



# **Heat Sensor**

## **Model CFH10**



# **Owner's Manual**

- **Rate of Rise Temperature Sensing**
- **Selectable Fixed Temperature Sensing**
- **Proprietary Wireless Connectivity**
- **Compatible with the Comm Link and the OmniShield App**

Assembled in the USA



SIGNALING



LISTED

# Table of Contents

General Information About Your Heat Sensor .....	page 3
Contents of Your Kit .....	page 4
Recommended Locations for Your Heat Sensor .....	page 5-6
Areas Not Appropriate for Heat Sensors .....	page 6
Complete Home Fire and Gas Protection .....	page 7
Acceptable Wireless Sensor Spacing.....	page 7
Heat Sensor Features and Functions .....	pages 8-10
Deactivating Your Heat Sensor.....	page 11
Creating Your Wireless Network .....	page 12
Adding a Sensor to Your Wireless Network .....	page 13
Removing a Sensor from Your Wireless Network.....	page 14
Choosing the Mounting Location in a Room.....	page 15-16
Applying the Self-Adhesive Warning Label.....	page 16
Cleaning Your Heat Sensor.....	page 16
How to Mount the Heat Sensor .....	pages 17
Heat Sensor Specifications .....	page 18
Important Fire Safety Information .....	page 19
Warning! Limitations of Heat Sensors .....	page 20
Limited Warranty .....	page 21
Replacement Guarantees .....	page 22

*This unit is required to be installed in conjunction with one or more smoke sensors. See Page 7 for additional information.*

*Applied Fire Technologies recommends a combination of early-detecting Smoke and CO Sensors as well as reliable Heat Sensors installed in their appropriate locations throughout the home.*

*Smoke, CO and Heat Sensors are not a substitute for an adequate homeowner's fire/property insurance policy.*

## About Your New Heat Sensor

Thank you for purchasing the CFH10 Heat Sensor. Heat Sensors play an important role in protecting your family and home from the dangers of fire. Please carefully read and follow the information in this booklet to ensure that your sensor operates properly and is located in the areas best suited for activation.

## What Makes the CFH10 Heat Sensor Different?

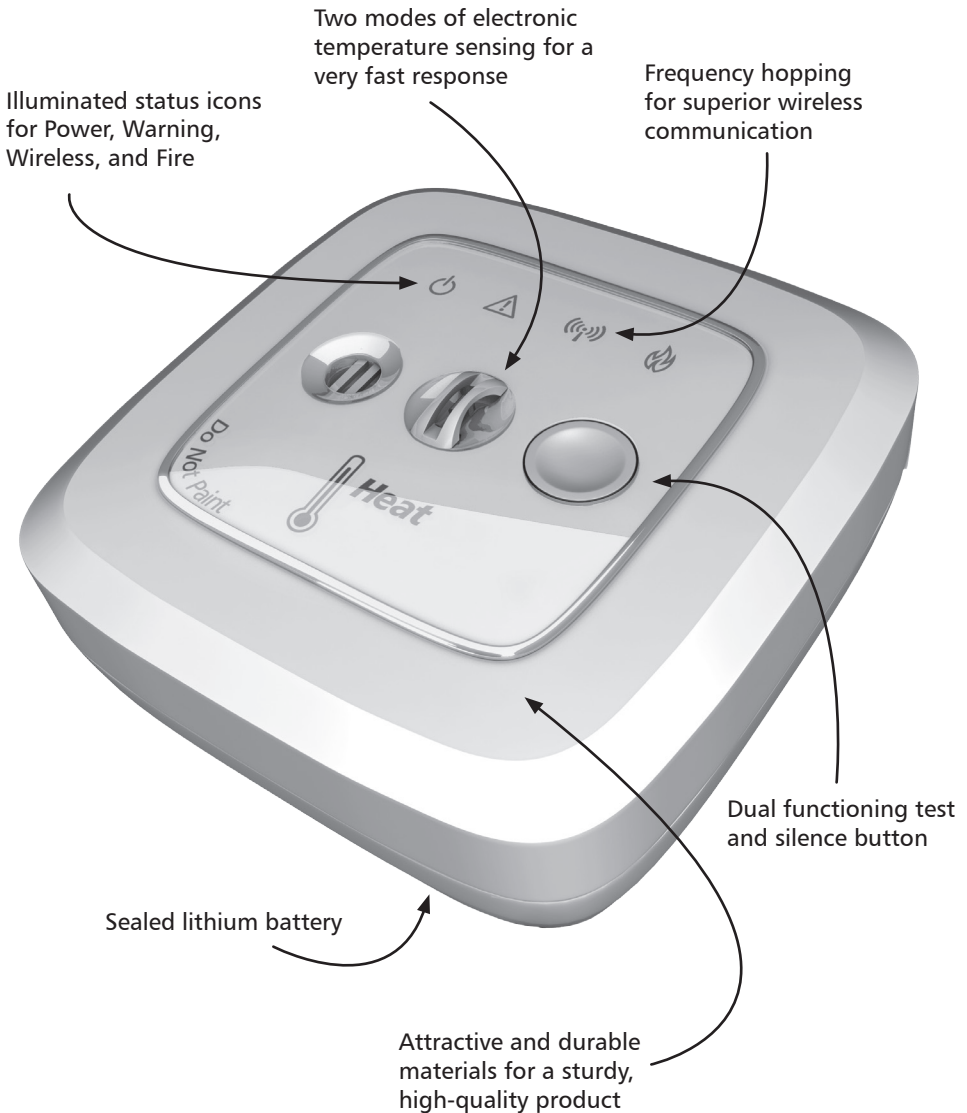

# Contents of Your Kit

Please make sure the following is included with your heat sensor:

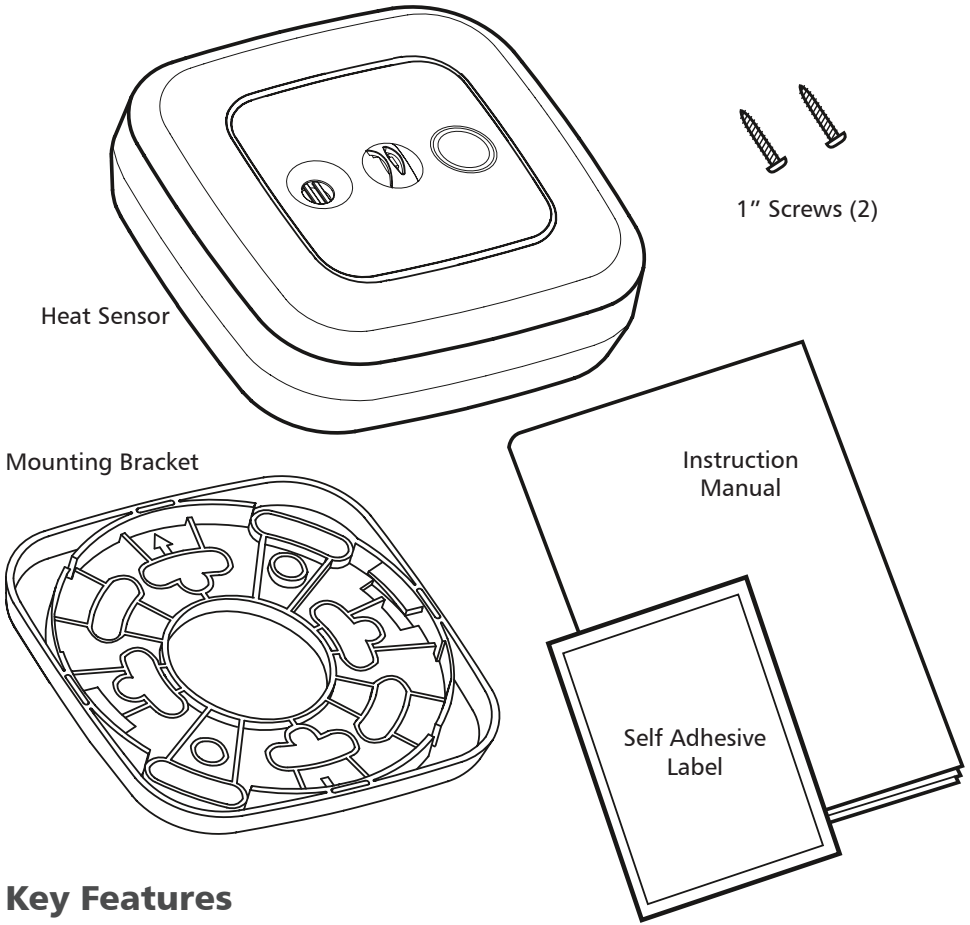

## Key Features

- The latest dual-sensor differential heat sensing technology.
- Rate of Rise and selectable Fixed Temperature triggers (117°F, 135°F and 175°F).
- Wireless communication to connect all Sensors into their own unique home network.
- Powered by a sealed lithium battery.
- Four illuminated icons to easily demonstrate the Sensor's status.
- Multi-function button to allow for testing and silencing of unwanted triggering.
- Uniquely loud horn to notify occupants of fire danger.
- Top quality construction to ensure a beautiful appearance and durability.
- Compatible with the Comm Link and OmniShield App.

## Recommended Locations for Your Heat Sensor

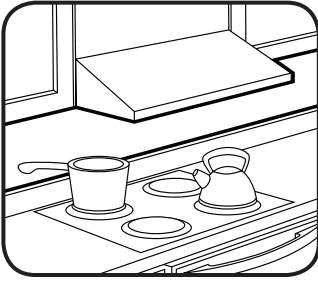

**Kitchens.** Most household fires originate in the kitchen. The CFH10 is ideal for the kitchen since it is not activated by the by-products of cooking (i.e. smoke or cooking scents). The recommended Fixed Temperature Setting for kitchens is 117°F (47°C)

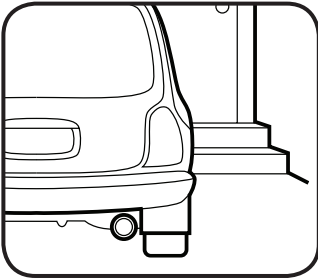

**Garages.** Exhaust gases from vehicles will not trigger the Heat Sensor. The recommended Fixed Temperature Setting for garages is 135°F (57°C)

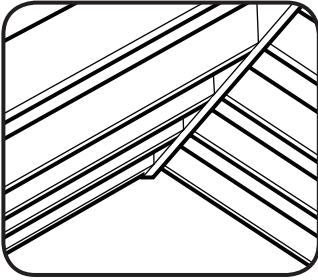

**Attics.** The CFH10 is not affected by dust, small insects or seasonal changes in temperature. The recommended Fixed Temperature Setting for attics is 175°F (79°C). However in cooler regions a 135°F (57°C) setting may be used.

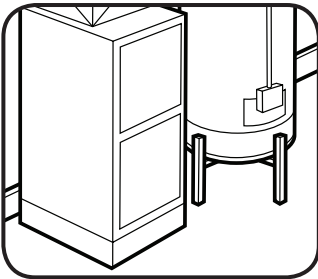

**Utility and Furnace Rooms.** The low volume steam and gases produced by mechanical equipment will not activate the CFH10. The recommended Fixed Temperature Setting is 135°F (57°C).

## Recommended Locations for Your Heat Sensor

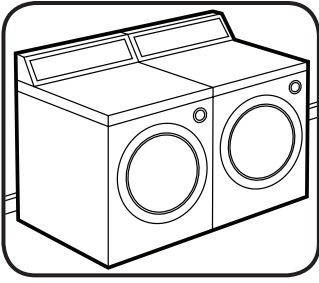

**Laundry Areas.** The low volume steam and gases produced by dryers and other equipment will not trigger the CFH10. The recommended Fixed Temperature Setting for laundry areas is 117°F (47°C)

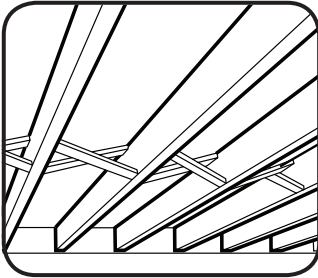

**Basements and Crawlspaces.** The Heat Sensor is not affected by dust, small insects or seasonal changes in temperature. The recommended Fixed Temperature Setting for basements and crawlspaces is 135°F (57°C)

## Areas Not Appropriate for Heat Sensors

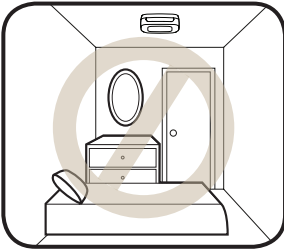

**Bedrooms.** Smoke Sensors are required protection in all sleeping rooms. A bedroom is NOT a good location for a stand-alone heat sensor.

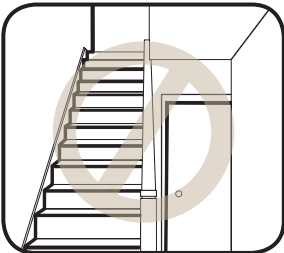







**Hallways.** A Heat Sensor is not recommended for installation in hallways. This area should be equipped with smoke and CO Sensors.

*Note: Applicable building codes or other local laws may require the installation of CO and Smoke Sensors in addition to the minimum recommended by this manual.*

# Complete Home Protection

Applied Fire Technologies recommends complete home fire/safety protection. This can be best achieved by installing a combination of Smoke, CO, Heat Sensors, BedShakers, Water Sensors and a Comm Link in the appropriate locations throughout the home.

-  Minimum Required Smoke Sensors
-  Minimum Required CO Sensors
-  Recommended Heat Sensors
-  Recommended BedShakers
-  Recommended Comm Link
-  Recommended Water Sensors
- Required Interconnections

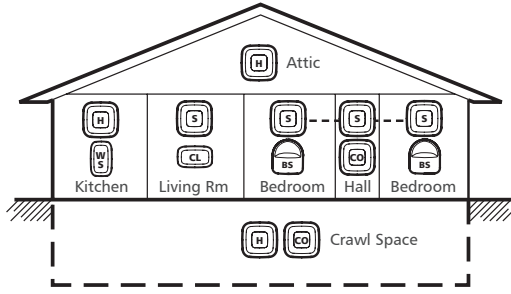

**Single Story Homes**

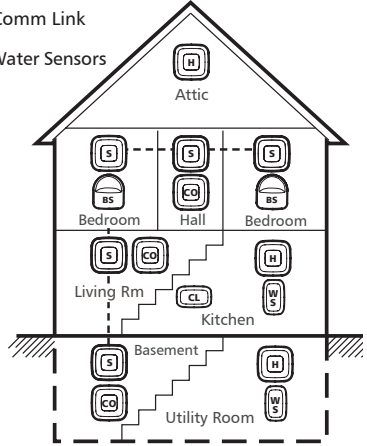

**Two Story Homes**

## Acceptable Radio Network Sensor Spacing

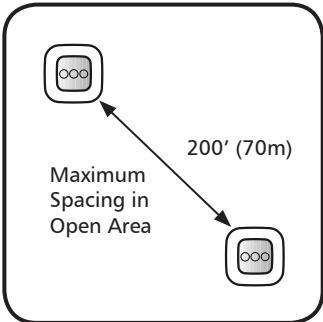

The proprietary network communicates using radio frequencies between 905.2MHz and 913.2MHz.

The range of the radio has been tested to 200 feet (70m) in open area distance testing.

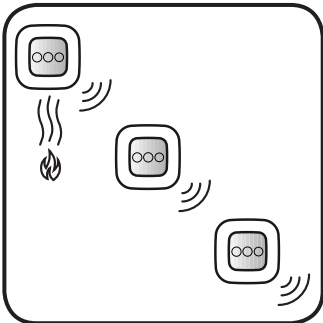

Each unit will also act as a repeating station, so any signal received by a sensor will be rebroadcast.

**After final installation, test all sensors for proper wireless inter-connection. Simply press and release the test button of a sensor while having a helper observe the remote sensors.**

## Heat Sensor Features and Functions

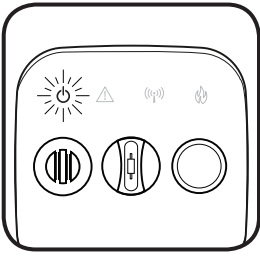

### Power Indicator Light (Green)

On the CFH10, the POWER icon will briefly flash once every 30 seconds once the sensor has been activated.

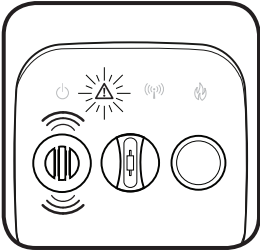

### Warning Light (Red)

WARNING will flash red every 30 seconds accompanied by the horn chirp, for a minimum of 7 days, to indicate **Low Battery**. Replace the sensor.

WARNING will double flash red every 30 seconds accompanied by the horn chirp, to indicate that the sensor's heat sensor has reached its **End-of-Life**. Replace the sensor.

WARNING can also be activated by a remote signal from a **CO sensor**. In this case, WARNING will be solid red accompanied by 4 beeps of the horn.

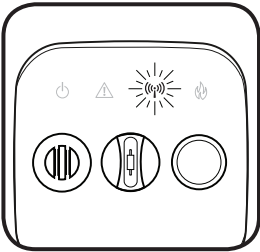

### Wireless Networking Light (Blue)

WIRELESS will flash once per second to indicate the wireless network is open to accept additional sensors into the network.

WIRELESS will cease to flash one minute after the last sensor has been added to the network or immediately after the button has been pressed.

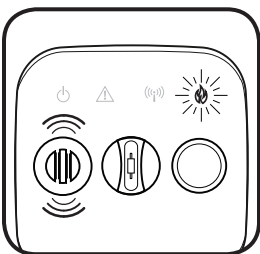

### Fire Warning Light (Red)

The FIRE warning light can be triggered in two ways on the Heat Sensor, either with exposure to sufficient heat or remotely by another sensor on the wireless network.

FIRE will **flash** when the sensor detects sufficient quantities of heat. This is accompanied by the sounding of the horn.

FIRE will stay on **continuously** if the sensor was triggered remotely by another sensor on your wireless network. A remotely triggered sensor will exit alarm mode after 5 minutes, unless during that time it was able to directly detect the fire.

FIRE will continue to flash twice per minute (without the horn) for three days after exiting an alarm condition, or until the front button has been pressed and released.



# Heat Sensor Features and Functions

## Selecting the Fixed Temperature Setting

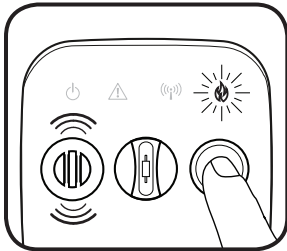

The CFH10 has three selectable fixed temperatures available: 117°F (47°C), 135°F (57°C) and 175°F (79°C). They can be selected as follows:

**Press and hold** the button on the front cover of the Heat Sensor. The **red FIRE** light will flash rapidly and the sensor will sound three tones.

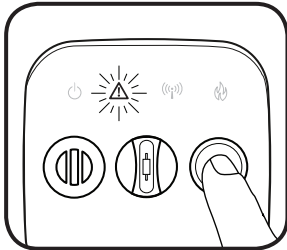

Next, the **yellow WARNING** light will flash slowly. Count to **3 flashes** of the yellow WARNING light and release the button.

If done correctly, either the yellow WARNING, blue WIRELESS or red FIRE light will now be on.

*If not, wait about 15 seconds and carefully repeat these steps.*

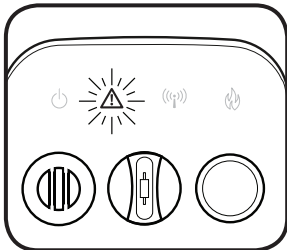

The factory Fixed Temperature Setting is 117°F (47°C). To change to the higher settings, simply press and release the button.

The 117°F is set when the yellow WARNING light is displayed.

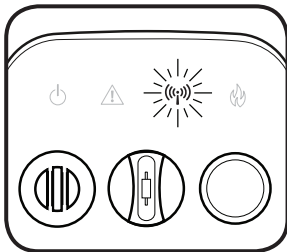

Press and release the button again, and the next available temperature setting is 135°F (57°C).

The 135°F is set when the blue WIRELESS light is displayed.

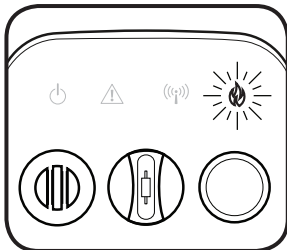

Press and release the button again, and the next available temperature setting is 175°F (79°C).

The 175°F is set when the red FIRE light is displayed.

This operation can be repeated until the desired temperature has been selected. After a few seconds, the light will go out and the temperature is set.

# Heat Sensor Features and Functions

## Testing the Heat Sensor

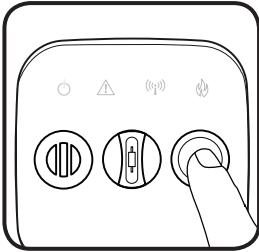

Every Heat Sensor should be tested at least weekly to ensure proper operation.

To test the sensor, press and release the button on the front face.

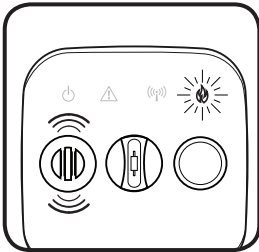

The sensor will sound with 3 beeps and the FIRE icon will flash red rapidly.

All four icons will strobe to indicate a successful test.

The sensor will then send out a network test command and all other sensors on the wireless network will perform the same internal test.

***If the sensor fails the self-test, the horn will sound a single long tone. If this occurs, replace the unit.***

## Silencing Nuisance Alarms

The CFH10 sensor is equipped with a silence feature that can silence the unit.

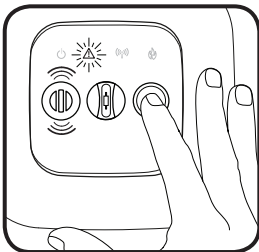

If during normal operation the sensor is triggered, ***and all appropriate safety precautions are being taken***, the sensor can be silenced for ten minutes by pressing the button on the front face of the unit.

The silence feature will also silence any sensors that were triggered remotely. However, the initiating sensor must be silenced directly.

# Deactivating the CFH10 Heat Sensor

**DO NOT MOVE THE SWITCH TO THE DEACTIVATE POSITION UNLESS YOUR INTENT IS TO DISPOSE OF THE UNIT!**

When the sensor's End-of-Life or Low Battery signal occurs, the sensor must be deactivated and disposed of properly. Have a replacement heat sensor available.

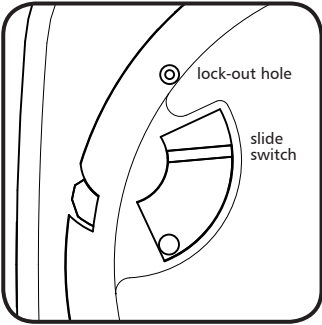

If the sensor's End-of-Life or Low Battery signal has begun, remove the unit from its bracket.

Locate the slide switch and the deactivation lock-out hole of the back of the heat sensor.

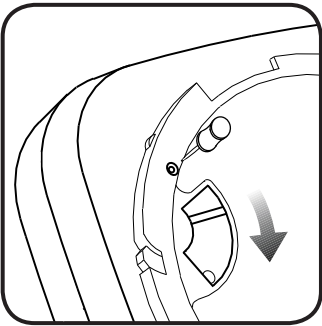

To deactivate the heat sensor, insert a pin or bent paperclip into the deactivation lock-out hole. Hold the pin down firmly.

With the pin still pressed firmly in place, slide the switch in the direction indicated by the arrow in the drawing.

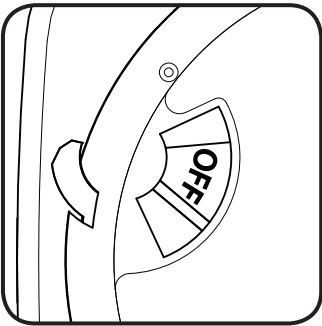

When the switch is fully positioned the word "OFF" will be exposed.

The switch will lock permanently into place. **The heat sensor cannot be reactivated!**

**DO NOT MOVE THE SWITCH TO THE DEACTIVATE POSITION UNLESS YOUR INTENT IS TO DISPOSE OF THE UNIT!**

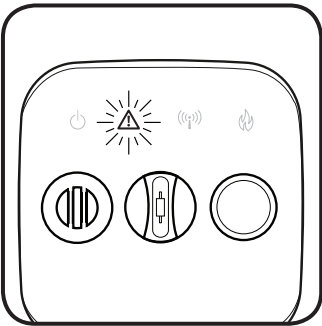

After the deactivation switch has been thrown, the WARNING light will turn on. This will deplete any remaining battery power over a period of several hours.

*After the light has gone out, responsibly dispose of the heat sensor and **replace with a new heat sensor!***

# Creating Your Wireless Network

The CFH10 sensor communicates on its own private home network. This network is created simply by powering up new sensors one at a time.



Activate your first sensor by moving the slide switch located on the back side of the sensor in the direction indicated by the white arrow.

The slide switch will lock into place when fully positioned.

**Note:** This switch is connected to a lock-out mechanism that will prevent installation on the bracket until activated.

**General Note:** It is easiest to first create the wireless network while all sensors are located together, such as on a table.

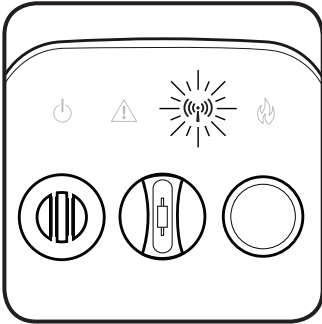

The blue WIRELESS light will begin to flash slowly.

While the blue WIRELESS light is flashing, additional sensors may be added to your network.

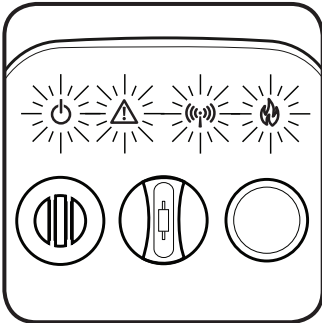

Activate your next sensor by moving its slide switch as shown above.

The blue WIRELESS light will flash briefly, then the sensor will chirp twice and all four of the lighted icons will strobe on in succession.

**This heat sensor has been added to your network!**

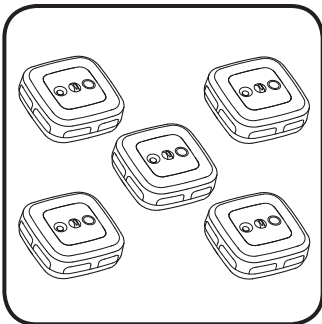

Continue activating each new unit, one sensor at a time, until all sensors have been added to the network. This should include smoke and CO sensors as well.

*One minute after activating the last sensor, the WIRELESS light will stop flashing on the original sensor, and it will join the network. The network is now closed.*

**General Note:** The wireless network is limited to 18 total units. Only 12 of these units may be smoke sensors, the remaining units can be CO, heat, and bed shakers.

## Adding a Sensor to Your Wireless Network

To add a sensor(s) to your existing home network, perform the following steps.

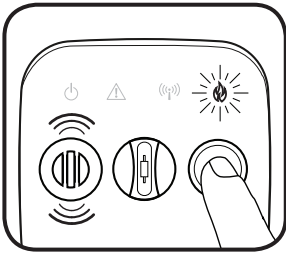

Select any sensor on the existing network. **Press and hold** the button on the front cover of the sensor. The **red FIRE** light will flash rapidly and the sensor will sound three tones.

Continue holding the button down.

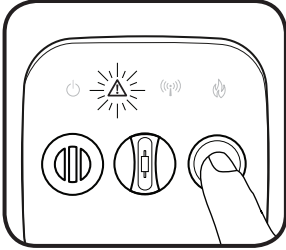

Next, the **yellow WARNING** light will flash slowly. Count to **5 flashes** of the yellow WARNING light and release the button.

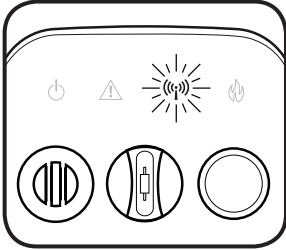

If done correctly, the blue WIRELESS light will now slowly pulse, indicating the network is again ready to receive additional sensors.

*If not, wait about 15 seconds and carefully repeat these steps.*

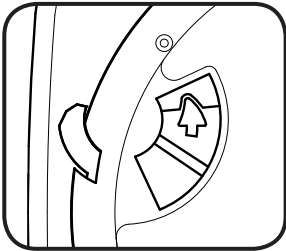

To add a **new** sensor, simply slide the switch located on the back side of the new sensor in the direction indicated by the white arrow. It will lock into place when fully positioned.

*If the sensor being added was previously used, follow the steps on Page 14 to erase its network data. Then re-open this sensor's wireless function using steps 1-2 in this section.*

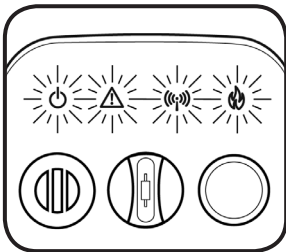

The blue WIRELESS light will flash briefly, then the sensor will chirp twice and all four of the lighted icons will strobe on in succession.

**The Heat Sensor has been successfully added to your network!**

*Press the button on the original sensor and the WIRELESS light will stop flashing, or after one minute the WIRELESS light will stop flashing automatically and the network will close.*

# Removing a Heat Sensor from a Wireless Network

In the event that a heat sensor must be removed from your network, the sensor's network data must be erased from its memory.

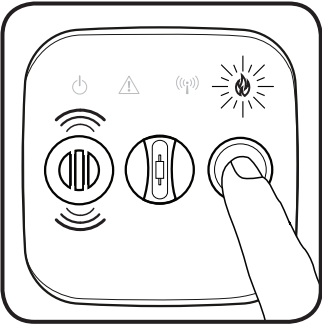

Press and hold the button on the front cover of the sensor. The red FIRE light will flash rapidly and the sensor will sound three tones.

Continue holding the button down.

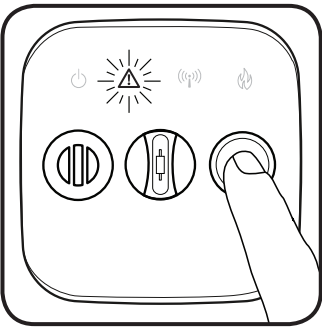

Next, the WARNING light will begin to flash yellow. Count **10 flashes** of the yellow WARNING light and release the button.

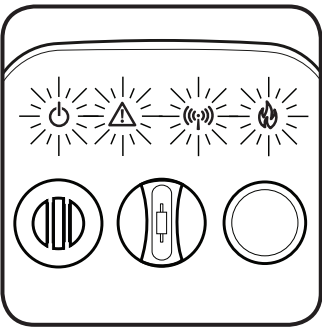

The heat sensor will chirp twice and all four of the lighted icons will strobe on.

**All network data has been erased from the heat sensor.** It will now perform as a single station sensor or it can be joined to a new network.

# Choosing the Mounting Location in a Room

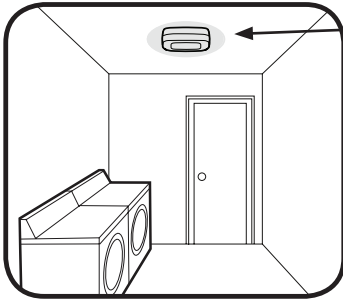

**BEST**  
Center on ceiling.

**Note:** Avoid placement of sensors close to ceiling fans or heating/air conditioning vents.

**CAUTION:** To avoid a false alarm, do not use where maximum ambient temperature will exceed 25°F below the Fixed Temperature Setting selected.

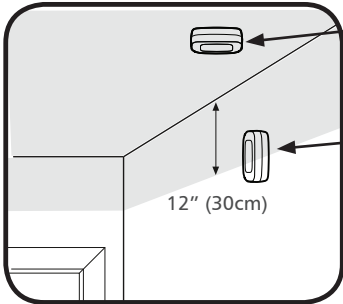

**ACCEPTABLE**  
On ceiling

**ACCEPTABLE**  
On wall, the top of the sensor must be no more than 12" (30 cm) from the ceiling (if local codes permit wall mounting).

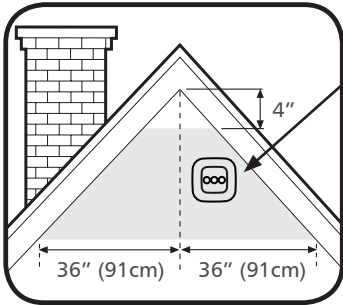

**ACCEPTABLE**  
On peaked ceilings or roofs, mount at least 4" (10cm) from the upper corner, but high enough to allow a maximum of 36" (91cm) of horizontal air space as measured off the peak.

Do not mount Heat Sensors between joist or rafters; mount on the exposed surface of the joist.

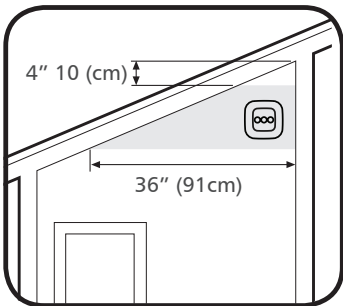

**ACCEPTABLE**  
On sloped ceilings, at least 4" (10cm) from the upper corner, but high enough to allow a maximum of 36" (91cm) of horizontal air space as measured off the peak.

## Choosing the Mounting Location in a Room

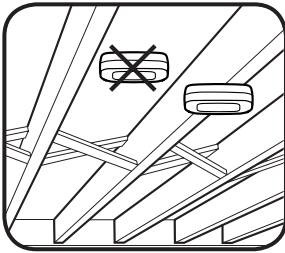

### **NO!**

Do not install between joists or rafters.

### **OK**

Install on exposed face of joist or rafter.

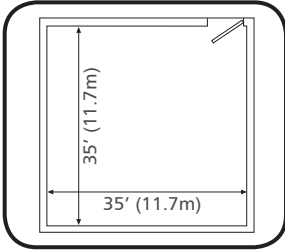

### **Room Coverage Area**

The Heat Sensor has a space rating of 50' (15.2m)

This will cover a room of 35' x 35' (10.7m x 10.7m)

**General Note:** Do not install within 36" (91cm) of heating/cooling vents, or where drapes or furniture impede air flow.

## Applying the Self-Adhesive Warning Label



This Heat Sensor was shipped with a self-adhesive Warning Label.

Place the label in the general area near the heat sensor, on an adjacent door, or the equivalent. This label contains information on the capabilities and some limitations of heat sensors.

## Cleaning Your Heat Sensor

Over time, dust might collect on the surface of your Heat Sensor. To clean the heat sensor, perform the following:

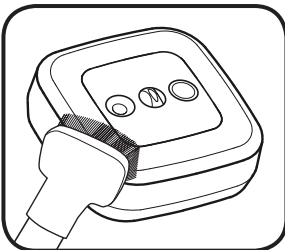

Remove the sensor from its bracket.

Vacuum all the external surfaces carefully. Wipe with a clean, dry cloth. Do not use cleaners or solvents.

Press and release the Test button on the front face to verify the sensor is still functioning properly and reinstall on the wall/ceiling.

Do not submerge the Heat Sensor in water. The sensitive electronics will be damaged!



# How to Mount the Heat Sensor

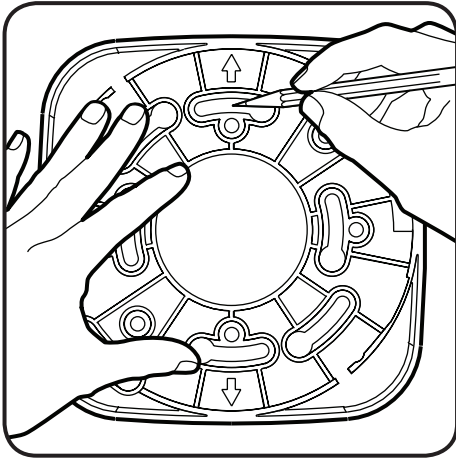

## 1 Mark

Place the mounting bracket against the ceiling or wall, and using the mounting bracket as a template, mark the top and bottom holes with a pencil.

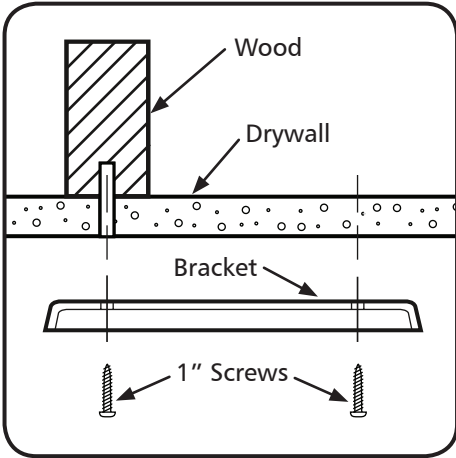

## 2 Mount the Bracket

If wood is present behind the drywall, a pilot hole can ease installation, but is not required. Create the optional pilot hole with a 1/8" (3mm) drill bit.

If the screw will only be secured into drywall, **DO NOT** drill a pilot hole.

Securely fasten the mounting bracket to the ceiling or wall using the two 1" screws provided. Do not over tighten.

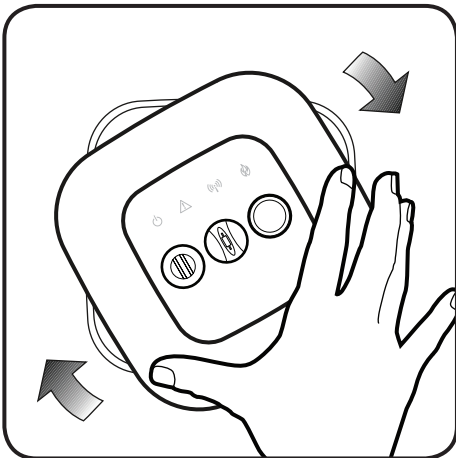

## 3 Lock Into Place

With the heat sensor activated and all sensors fully networked together, position the heat sensor onto the center of the bracket and turn clockwise. The sensor will lock into place.

# Heat Sensor Specifications

<b>Operating Voltage</b>	3VDC
<b>Battery Type</b>	Non-replaceable Lithium-Manganese
<b>Fixed Temperature Settings</b>	117°F (47°C) 135°F (57°C) 175°F (79°C)
<b>Rate of Rise</b>	20°F (11°C) / minute, > 100°F (38°C)
<b>Space Rating</b>	50 feet
<b>Operating Ambient Temperature</b>	-20°F to 135°F (-29°C to 57°C)
<b>Operating Humidity</b>	10 - 95% Non-condensing
<b>Sensor Dimensions</b>	5.1" x 5.1" x 1.75"
<b>Mounting Base Dimensions</b>	5.0" x 5.0"
<b>Weight</b>	0.74 lbs
<b>Listings</b>	UL; CSFM

## FCC Compliance Statement

This device complies with part 15 of the FCC Rules. Operation is subject to the following two conditions: (1) This device may not cause harmful interference, and (2) this device must accept any interference received, including interference that may cause undesired operation.

This equipment has been tested and found to comply with the limits for a Class B digital device, pursuant to part 15 of the FCC Rules. These limits are designed to provide reasonable protection against harmful interference in a residential installation. This equipment generates, uses and can radiate radio frequency energy and, if not installed and used in accordance with the instructions, may cause harmful interference to radio communications. However, there is no guarantee that interference will not occur in a particular installation. If this equipment does cause harmful interference to radio or television reception, which can be determined by turning this equipment off and on, the user is encouraged to try to correct the interference by one or more of the following measures:

(1) Reorient or relocate the units. (2) Increase the separation between the equipment and receiver. (3) Connect the equipment into a different circuit from that to which the receiver is connected. (4) Consult the dealer or an experienced technician for help.

FCC Caution: Changes or modifications not expressly approved by the manufacturer could void the user's authority to operate the equipment.

# Important Fire/Emergency Safety Information

Be prepared for fire emergencies:

## Plan Your Escape

- Draw a floor plan of your home.
- Show two ways out of each room.
- Discuss escape routes with everyone in your home.
- Agree on an outside meeting place where you will gather after escaping.

## Be Prepared

- Familiarize every member of the household with the sound of the Smoke, CO and Heat Alarms.
- Have everyone in the home memorize the fire department's emergency phone number.
- Instruct each person to call the emergency number from a neighbor's phone or a mobile phone used outside the home.
- Teach everyone to unlock and open all windows, and release security bars.
- Make sure security bars are equipped with quick-release devices.
- Keep exits clear and free from furniture and clutter.

## Practice!

- Hold home fire drills at least twice a year.

## Get Out and Stay Out

- Once you've escaped from a fire, do not go back inside for any reason.
- Make fire drills realistic by pretending some escape paths are blocked by smoke or fire.

## If you live in an apartment building

- Learn and practice your building's evacuation plan.
- If you hear a fire alarm, react immediately.
- Know the location of all building exits and fire alarm boxes.
- Use the stairs ... never use an elevator during a fire.
- If exits are locked or blocked, report the problem to your building's management.

## Escape Tips

- Close doors behind you as you escape to slow the spread of fire and smoke.
- If you have to escape through smoke, crawl on your hands and knees, keeping your head one to two feet above the floor, where the air will be clearest.
- Test the doorknob and spaces around the door with the back of your hand. If the door is warm, try another escape route. If the door is cool, open it slowly. Close it quickly if smoke pours through.

## **WARNING! Limitations of Heat Sensors**

Wireless Heat Sensors have been proven to be both effective and reliable, but they may not be effective under all conditions. No sensor design can offer total protection of life and property. A Heat Sensor is not a substitute for an adequate homeowner's property insurance or life insurance policy.

Heat Sensors will not work without a source of power. The sensor will not operate and the sensor will not sound if the battery has died or the unit has been deactivated.

**CAUTION** - This sensor will only indicate the presence of heat at the sensor. Heat may be present in other areas.

Radio communication between sensor units may fail to take place if significant changes to the home have occurred since installation and testing. Moving large objects, such as a refrigerator or metal cabinet, could impede sensor radio performance. Test heat sensors weekly.

Sensor warning signals may not be heard. A deep sleeper, hearing-impaired person, young child or someone impaired by drugs or alcohol may not awaken in response to a heat sensor activation. This can occur even when a sensor is located inside the individual's bedroom. Be sure emergency exit drills are practiced that take this possibility into account.

Heat Sensors may not always activate and provide early enough warning. A Heat Sensor will only activate when it is maintained in working order and sufficient amounts of heat reaches the unit.

**HEAT SENSORS CANNOT GUARANTEE THAT YOU WILL NEVER SUFFER ANY ILLNESS OR INJURY FROM EXPOSURE TO HEAT OR FIRE.**

**WARNING** - The installation of Heat Sensors should not be used as a substitute for proper installation, use, and maintenance of Smoke Sensors and Carbon Monoxide Sensors. Heat Sensors are to be considered additional protection.

## **National Fire Protection Association Standards**

This equipment should be installed in accordance with the National Fire Protection Association's Standard 72 (NFPA, Batterymarch Park, Quincy, MA 02269)

For your information, the NFPA Standard 72 reads as follows:

29.5.1.1 \* Where required by other governing laws, codes, or standards for a specific type of occupancy, approved single- and multiple-station smoke Sensors shall be installed as follows:

- (1) \* In all sleeping rooms and guest rooms
- (2) \* Outside of each separate dwelling unit sleeping area, within 21ft of any door to a sleeping room, with the distance measured along the path of travel
- (3) On every level of a dwelling unit, including basements
- (4) On every level of a residential board and care occupancy (small facility), including basements and excluding crawl spaces and unfinished attics
- (5) \* In the living area(s) of a guest suite
- (6) In the living area(s) of a residential board and care occupancy (small facility)

## Limited Warranty

For a period of 24 months from the date of purchase, Applied Fire Technologies LLC warrants to you, the original consumer purchaser, that your CFH10 Heat Sensor will be free from defects in workmanship, materials, and construction under normal use and service. If a defect in workmanship, materials, or construction should cause your CFH10 Sensor to become inoperable within the warranty period, Applied Fire Technologies LLC will repair your CFH10 Sensor or furnish you with a new or rebuilt replacement CFH10 Sensor without charge to you except for your costs of shipping the CFH10 Sensor to Applied Fire Technologies LLC for warranty coverage. Your repaired or replacement CFH10 Sensor will be returned to you without charge and will be covered under this warranty for the remainder of the warranty period.

This warranty will not apply if inspection of your CFH10 Sensor shows that the damage or failure was caused by abuse, misuse, abnormal usage, faulty installation, improper maintenance, or work other than that performed by authorized service personnel.

Any warranties implied under any State law, including implied warranties of merchantability and fitness for a particular purpose, are limited in duration to the period of this limited warranty. Some states do not allow limitations on how long an implied warranty lasts, so the above limitation may not apply to you. Applied Fire Technologies LLC will not be liable for any loss or damages, incidental or consequential, of any kind arising in connection with the sale, use, operation, inoperability, malfunction, or repair of your CFH10 Sensor. Some states do not allow the exclusion or limitation of incidental or consequential damages, so the above limitation or exclusion may not apply to you.

If a defect in workmanship, materials, or construction should cause your CFH10 Sensor to become inoperable within the warranty period, to obtain warranty coverage you must ship the CFH10 Sensor to Applied Fire Technologies LLC, with shipping costs prepaid by you. You must also pack the CFH10 Sensor to minimize the risk of it being damaged in transit. You must also enclose a return address. CFH10 Sensors returned for warranty service should be sent to: Applied Fire Technologies LLC, 825 W. Sandy Lake Rd., Suite 190, Coppell, TX 75019 USA, accompanied by proof of purchase.

If Applied Fire Technologies LLC receives a CFH10 Sensor in a damaged condition as the result of shipping, you will be notified and you may need to file a claim with the shipper.

This Limited Warranty gives you specific legal rights, and you may also have other rights which vary from state to state. This is your copy of the Limited Warranty on your CFH10 Sensor. Please retain it, along with proof of purchase showing the date of purchase and the identity of the purchaser, in a safe place.

## **Lifetime Product Replacement Guarantee**

After the Limited Warranty has expired, commencing on the first day of the 25th month and extending through the lifetime of customer, Applied Fire Technologies LLC guarantees to repair or replace the Heat Sensor at a preferred owner discounted price, which includes shipping and handling and is adjusted annually. This Product Replacement Guarantee does not create any obligations or liabilities on the part of Applied Fire Technologies LLC.

This guarantee is extended only to the original purchaser and is available when the Heat Sensor is sent to the manufacturer, with a description of any problem and proof-of-purchase. This replacement guarantee will not apply if the manufacturer's inspection reveals that the damage or failure is a result of abuse, misuse, improper maintenance, abnormal usage, or work performed by unauthorized service personnel. At least an annual cleaning (according to the directions supplied in this owner's manual) is recommended to prolong the useful life of your CFH10 Sensor.

To obtain a replacement under this guarantee, contact the manufacturer at [www.homesafenetwork.com](http://www.homesafenetwork.com) or at 1 (972) 304-3923, to receive information as to then-applicable pricing and for the address to which you should send your CFH10 Sensor along with payment for your replacement Sensor. Be sure to enclose your return address and daytime telephone number. The CFH10 manufacturer will ship the new replacement unit to you upon its receipt of all of the foregoing materials and information.

This Product Replacement Policy does not alter or affect your Limited Warranty.

## **Lifetime Fire Replacement Guarantee**

The CFH10 Sensor manufacturer guarantees to replace at no cost to the original owner any CFH10 Sensor that has been materially damaged or destroyed by an accidental fire. To obtain a replacement Sensor under this Lifetime Fire Replacement Guarantee, you must return the damaged or destroyed Heat Sensor to the manufacturer within 90 days of the fire, accompanied by a complete activation report and verification report from the applicable fire department. To obtain a replacement under this guarantee, contact the manufacturer at Applied Fire Technologies LLC at [www.homesafenetwork.com](http://www.homesafenetwork.com) or at 1 (972) 304-3923, to receive information as to the address to which you should send your damaged or destroyed CFH10 Sensor and accompanying information.





825 W. Sandy Lake Road, Suite 190  
Coppell, TX 75019 USA  
[www.homesafenetwork.com](http://www.homesafenetwork.com)

*Model CFH10  
10-Year Battery Life  
Return to Above Address  
for All Service Needs*